

UNI12 BCD/U

- 7 diffusers to choose from
- increased radiation - it is possible to use a stronger LED strip
- 7 kloszy do wyboru
- zwiększona radiacja - możliwość zastosowania mocniejszej taśmy LED



max 12 mm



surface
nawierzchniowy



recessed
wpustowy

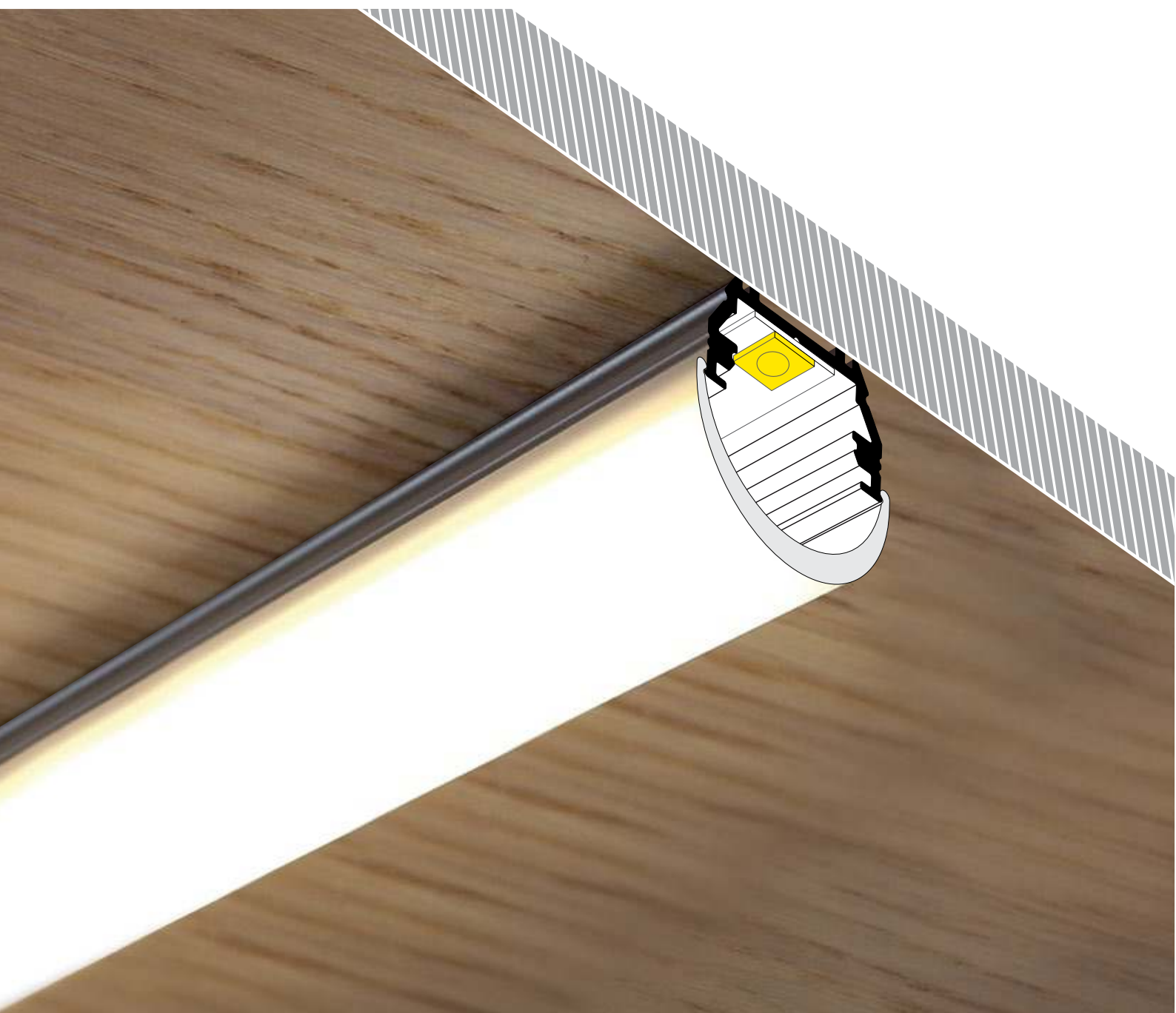

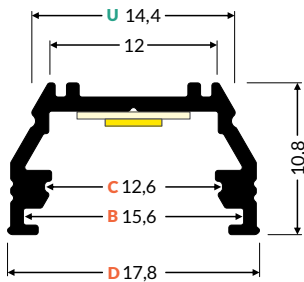

230-240 V AC
50-60 Hz

power supply
zasilacz

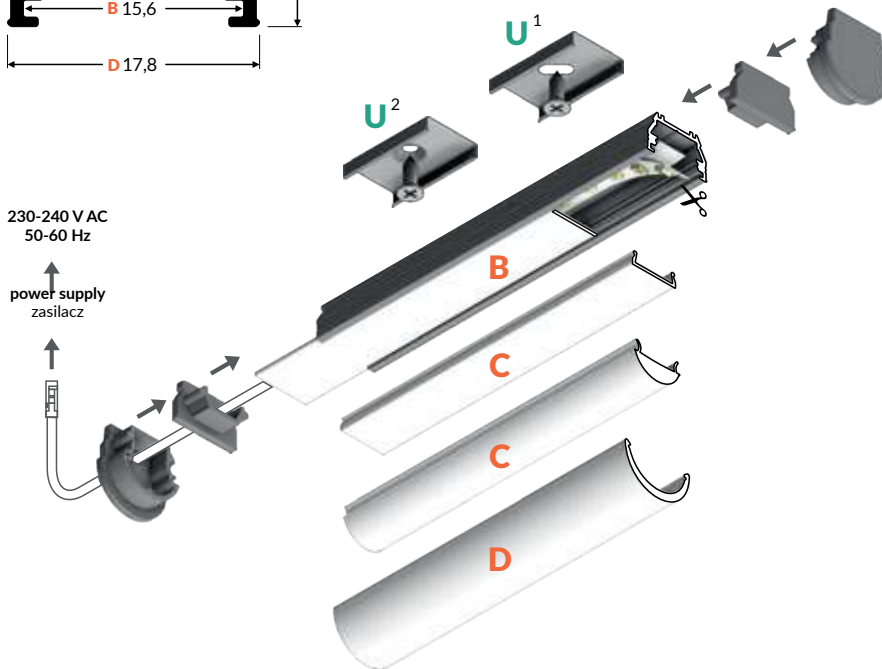

white painted
biały malowany
A1020001



anodized
anodowany
A1020020P



black anodized
czarny anodowany
A1020021



raw aluminium
surowe aluminium
A1020000P

INDEX = length 2000 mm
Quantities, package and other length available > check the pricelist. Technical details > 8-18
INDEKS = długość 2000 mm
Ilości, opakowanie, inne dostępne długości > patrz cennik. Szczegóły techniczne > 8-18

U¹

U flexible mounting
plate > 98
uchwyt U sprężysty
> 98

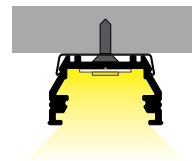

U²

cone U flexible mounting
plate > 98
uchwyt U sprężysty cone
> 98

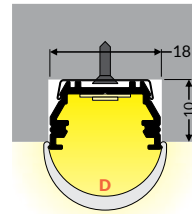
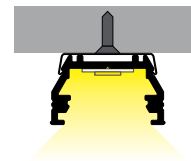

B
B slide diffuser > 94
klosz B wsuwany > 94

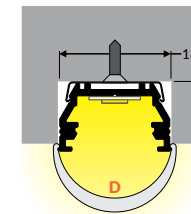

C
C lens diffuser > 94
klosz C soczewka > 94

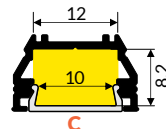

C
click diffuser > 94
klosz C klik > 94

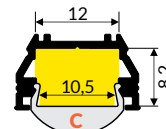

D
D click diffuser > 95
klosz D klik > 95

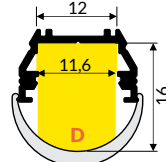

UNI12 end cap gen2
zaślepka UNI12 gen2



white / biały
A1900001
silver / srebrny
A1900040
black / czarny
A1900002
grey / szary
A1900022

UNI12 end cap gen2
with hole
zaślepka UNI12 gen2
z otworem



white / biały
A1890001
silver / srebrny
A1890040
black / czarny
A1890002
grey / szary
A1890022

UNI12 D end cap
zaślepka UNI12 D



white / biały
A1940001
silver / srebrny
A1940040
black / czarny
A1940002
grey / szary
A1940022

UNI12 D end cap
with hole
zaślepka UNI12
D z otworem



white / biały
A1960001
silver / srebrny
A1960040
black / czarny
A1960002
grey / szary
A1960022

ćcolours: white, anodized, black
material: aluminium

łącznik UNI12 90 st
kolory: biały, anodowany, czarny
materiał: aluminium

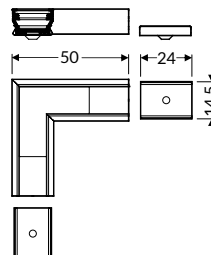

white painted
biały malowany
A1910001
anodized
anodowany
A1910020
black anodized
czarny anodowany
A1910021

Quantities and package > check the pricelist
Technical details > 8-18
Ilości i opakowanie > patrz cennik
Szczegóły techniczne > 8-18